

#9 MULTI-PURPOSE SCREW FLAT COUNTERSUNK HEAD

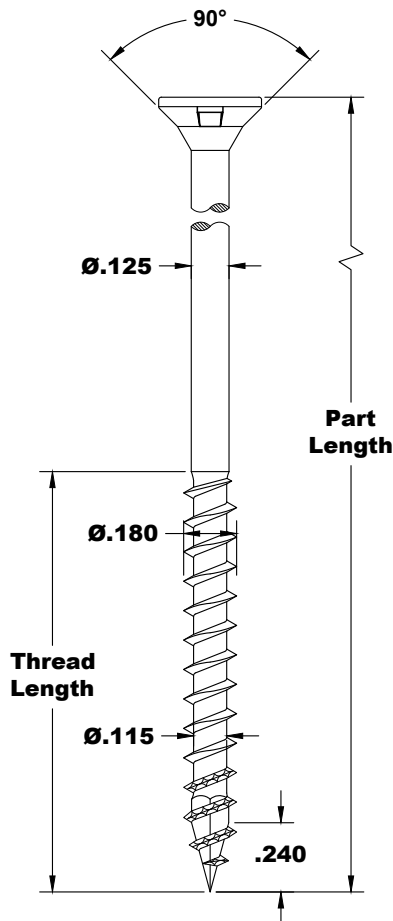
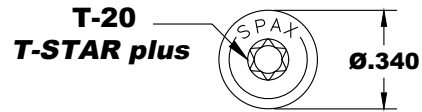

Size	Part Length	Thread Length
#9 x 1-1/2"	1.500	1.000
#9 x 2"	2.000	1.280
#9 x 2-1/2"	2.500	1.655
#9 x 3-1/4"	3.500	1.810

Notes:

-Nominal dimensions in inches with no tolerances

-Information contained in this document is subject to change and periodic updates. Please contact SPAX or refer to spax.us for current product information including available material types (i.e. carbon or stainless steel), and available coating options.

	SCALE NOT-TO-SCALE	DRAWN KLS	DESCRIPTION #9 MULTI-PURPOSE SCREW FLAT COUNTERSUNK HEAD	REV —
	DATE 6/11/19	CHECKED CHECKED		
	SHEET 1 of 1	APPROVED APPROVED	SIZE CP- A CP-XF_09	

PROPRIETARY - THIS MATERIAL IS THE SOLE PROPERTY OF ALTENLOH, BRINCK AND CO. U.S., INC. AND IS NOT TO BE REPRODUCED OR DISTRIBUTED WITHOUT PRIOR WRITTEN CONSENT FROM ALTENLOH, BRINCK AND CO. U.S., INC.